

# MAXIM

## MAX1448 Evaluation Kit

### General Description

The MAX1448 evaluation kit (EV kit) is a fully assembled and tested circuit board that contains all the components necessary to evaluate the performance of the MAX1444, MAX1446, MAX1448, or MAX1449 10-bit analog-to-digital converters (ADCs). The MAX1444/MAX1446/MAX1448/MAX1449 ADCs process differential or single-ended analog inputs. The EV kit allows the user to evaluate the ADCs with both types of signals from one single-ended analog signal. The digital output produced by the ADCs can be easily sampled with a user-provided high-speed logic analyzer or data-acquisition system. The EV kit comes with the MAX1448 installed. Order free samples of the MAX1444EHJ, MAX1446EHJ or MAX1449EHJ to evaluate these parts. The EV kit operates from a +3V power supply. It includes circuitry that generates a clock signal from an AC signal provided by the user.

### Features

- ◆ Up to 80Msps Sampling Rate
- ◆ Low-Voltage, Low-Power Operation
- ◆ Single-Ended or Fully Differential Signal Input Configuration
- ◆ Clock-Shaping Circuit
- ◆ Fully Assembled and Tested

### Ordering Information

PART	TEMP RANGE	IC PACKAGE
MAX1448EVKIT	0°C to +70°C	32 TQFP

### Component List

DESIGNATION	QTY	DESCRIPTION
C1, C2, C4–C8, C10, C16–C20, C22, C27, C33–C39	22	0.1μF, 50V X7R ceramic capacitors (0805) Taiyo Yuden UMK212BJ104KG or equivalent
C3, C9	2	10pF, 200V ceramic capacitors (0805) Murata GQM2195C2A100JB01
C11, C21, C24, C26, C28, C29, C31, C32	8	2.2μF, 10V tantalum capacitors (A) AVX TAJA225K010 or Kemet T494A225K010AS
C12–C15	4	10μF, 10V tantalum capacitors (B) AVX TAJB106M010 or Kemet T494B106K010AS
C23, C30	0	Not installed (0805)
C25	1	1000pF, 50V COG ceramic capacitor (0805) Murata GRM2195C1H102JA01
J1	1	2 × 20-pin header
JU1, JU2	2	2-pin headers
JU3, JU4	2	3-pin headers
L1, L2	2	Ferrite chip beads (1206) Fair-Rite Products Corp. 2512069007Y0 or HiQ Magnetics 436-2600
R1, R39	0	Not installed (0805)
R2, R3, R13–R23, R35	14	49.9Ω ±1% resistors (0805)

DESIGNATION	QTY	DESCRIPTION
R4, R5, R38	3	24.9Ω ±1% resistors (0805)
R8, R24–R33	11	100Ω ±1% resistors (0805)
R9, R10, R36	3	2kΩ ±1% resistors (0805)
R11	1	6.04kΩ ±1% resistor (0805)
R12, R37	2	4.02kΩ ±1% resistors (0805)
R40	1	10kΩ ±1% resistor (0805)
R41	1	3.9Ω ±5% resistor (0805)
R34	1	5kΩ potentiometer
T1	1	RF transformer Mini-Circuits ADT1-1WT
U1	1	MAX1448EHJ (32-pin TQFP)
U2	1	Dual CMOS differential line receiver (8-pin SO) Maxim MAX9113ESA
U3	1	Buffer/driver 3-state output (48-pin TSSOP) Texas Instruments SN74ALVCH16244DGG or Pericom PI74ALVCH16244A
SINGLE, DIFF, CLOCK	3	SMA PC-mount connectors
None	4	Shunts (JU1 to JU4)
None	1	MAX1448 PC board
None	1	MAX1448 data sheet
None	1	MAX1448 EV kit data sheet

Evaluates: MAX1444/MAX1446/MAX1448/MAX1449

# MAX1448 Evaluation Kit

## Part Selection Table

PART	SPEED (MSPS)
MAX1444EHJ	40
MAX1446EHJ	60
MAX1448EHJ	80
MAX1449EHJ	105

## Component Suppliers

SUPPLIER	PHONE	FAX
AVX	843-448-9411	843-448-1943
Fair-Rite Products	888-324-7748	888-337-7483
Kemet	864-963-6300	864-963-6322
Mini-Circuits	718-934-4500	718-934-7092
Murata	770-436-1300	770-436-3030
Pericom	800-435-2336	408-435-1100
Taiyo Yuden	800-348-2496	847-925-0899
Texas Instruments	972-644-5580	214-480-7800

**Note:** Please indicate that you are using the MAX1448, MAX1444, MAX1446, or MAX1449 when contacting these component suppliers.

## Quick Start

### Required Equipment

- DC power supplies:
  - Digital = +3V, 100mA
  - Analog = +3V, 100mA
- A function generator with low phase noise and low jitter for clock input (e.g., HP 8662A)
- A function generator for analog signal input (e.g., HP 8662A)
- A logic analyzer or data-acquisition system (e.g., HP 1663EP, HP 16500C)
- An analog bandpass filter (e.g., TTE elliptical function bandpass filter Q56 series)
- A digital voltmeter

The MAX1448 EV kit is a fully assembled and tested surface-mount board. Follow the steps below for board operation. **Do not turn on power supplies or enable function generators until all connections are completed.**

- 1) Connect one +3V power supply to VAIN1 and VAIN2. Connect the ground terminal of this supply to AGND.
- 2) Connect one +3V power supply to VDIN1 and

VDIN2. Connect the ground terminal of this supply to DGND.

- 3) Verify that shunts are not installed in jumpers JU1 (MAX1448 enabled) and JU2 (MAX1448 output enabled).
- 4) Connect the clock function generator to the CLOCK SMA connector.
- 5) Connect the output of the analog signal function generator to the input of the bandpass filter.
- 6) To evaluate differential analog signals, verify that shunts are installed on pins 1 and 2 of jumpers JU3 and JU4. Connect the output of the bandpass filter to the DIFF SMA connector. For single-ended analog signal evaluation, verify that shunts are installed on pins 2 and 3 of jumpers JU3 and JU4, and connect the output of the bandpass filter to the SINGLE SMA connector.
- 7) Connect the logic analyzer to the square pin header (J1).
- 8) Turn on both power supplies.
- 9) With a voltmeter, verify that +1.20V is measured across test points TP4 and TP5. If the voltage is not +1.20V, adjust potentiometer R34 until +1.20V is obtained.
- 10) Enable the function generators. Set the clock function generator to 2.4V<sub>P-P</sub> and frequency (f<sub>CLK</sub>) ≤ 80MHz. Set the analog signal function generator to 2V<sub>P-P</sub> and desired frequency. The two function generators should be phase locked to each other.
- 11) Set the logic analyzer to latch data on the clock's rising edge.
- 12) Enable the logic analyzer.
- 13) Collect data using the logic analyzer.

## Detailed Description

The MAX1448 EV kit is a fully assembled and tested circuit board that contains all the components necessary to evaluate the performance of the MAX1449, MAX1448, MAX1446, or MAX1444 10-bit ADC at a maximum clock frequency (f<sub>CLK</sub>) of 80MHz. These ADCs can process differential or single-ended analog inputs. With the proper board configuration, the user can evaluate the ADC with both types of signals by supplying only one single-ended analog signal to the EV kit.

The EV kit's PC board is designed as a four-layer board to optimize the performance of the MAX1448. Separate analog and digital power planes minimize noise coupling between analog and digital signals. For simple operation, the EV kit is specified to have +3V power

# MAX1448 Evaluation Kit

Evaluates: MAX1444/MAX1446/MAX1448/MAX1449

supplies applied to analog and digital power planes. However, the digital supply can be operated down to +1.7V without compromising the board's performance. The logic analyzer's threshold should be adjusted accordingly.

Access to the output is provided through connector J1. The 40-pin connector can easily interface directly to a user-provided logic analyzer or data-acquisition system.

## Power Supplies

The MAX1448 EV kit requires separate analog and digital power supplies for best performance. A +3V power supply is used to power the analog portion of the MAX1449/MAX1448/MAX1446/MAX1444 ADC and the clock signal circuit. The MAX1449/MAX1448/MAX1446/MAX1444 analog supply voltage has a range of +2.7V to +3.3V; however, +3V must be supplied to the EV kit (VAIN1, VAIN2) to meet the minimum input voltage supply to the clock signal generator. A separate +3.0V power supply is used to power the digital portion (VDIN1, VDIN2) of the MAX1448 ADC and the buffer/driver, but it will operate with a voltage supply as low as +1.7V and as high as +3.3V. Enhanced dynamic performance can be achieved when the digital supply voltage is lower than the analog supply voltage.

## Clock

An on-board clock-shaping circuit generates a clock signal from an AC sine-wave signal applied to the CLOCK SMA connector. The signal should not exceed 2.6V<sub>p-p</sub>. The typical clock frequency should be 80MHz or less. The frequency of the sinusoidal input signal determines the sampling frequency of the ADC. A DS90LV028A differential line receiver processes the input signal to produce the CMOS clock signal. The signal's duty cycle can be adjusted with potentiometer R34. A clock signal with a 50% duty cycle can be achieved by adjusting R34 until +1.2V is produced across test points TP4 and TP5 at +3V analog voltage supply (40% of the analog power supply).

## Input Signal

The MAX1448 ADC is able to process differential or single-ended analog input signals. The EV kit requires only one single-ended analog input signal provided by the user. During single-ended signal operation, the signal is applied directly to the ADC, and in differential signal operation, an on-board transformer takes the single-ended analog signal and generates a differential analog signal at the ADC's differential input pins. For single-ended or differential signal board operation, see Table 1 for jumper configuration.

**Note:** When a differential signal is applied to the ADC, its positive and negative input pins each receive half of the input signal supplied at SMA connector DIFF centered at (VAIN1) / 2.

## MAX1448 Enable/Shutdown

The MAX1448 EV kit features jumpers to enable and disable the MAX1448 (JU1) or its digital outputs (JU2). See Table 1 for jumper settings.

## External Voltage Reference

The MAX1448 ADC requires an input voltage reference at pin 31 (REFIN) to set the full-scale analog signal voltage input. The ADC also has a stable on-chip voltage reference of +2.048V that can be accessed at REFOUT. The EV kit was designed to use the on-chip voltage reference by connecting REFIN to REFOUT through resistor R40. The user can externally adjust the reference level, and hence the full-scale range, by installing a resistor at R39. The adjusted reference level can be calculated by applying the following equation;

$$V_{REFIN} = (R39 / (R40 + R39)) \times V_{REFOUT}$$

where R39 is the value of the resistor installed, R40 is a 10kΩ resistor, and V<sub>REFOUT</sub> is +2.048V. Alternatively, the user can also apply a stable, low-noise, external reference voltage directly at the REFIN pad to set the full scale.

**Table 1. MAX1448 EV Kit Jumper Selection**

JUMPER	SHUNT STATUS	PIN CONNECTION	EV KIT OPERATION
JU1	CLOSED	PD connected to VDDUT	MAX1448 is disabled (powered down)
	OPEN	PD connected internally to GND	MAX1448 is enabled
JU2	CLOSED	$\overline{OE}$ connected to VDDUT	MAX1448 digital outputs are disabled
	OPEN	$\overline{OE}$ connected internally to GND	MAX1448 digital outputs are enabled
JU3, JU4	1 and 2	IN+ and IN- pins connected to SMA connector DIFF	Analog input signal is coupled into the ADC as a differential input
	2 and 3	IN+ pin connected to SMA connector SINGLE and IN- pin connected to COM pin	Analog input signal is coupled into the ADC as a single-ended input

# Evaluates: MAX1444/MAX1446/MAX1448/MAX1449

## MAX1448 Evaluation Kit

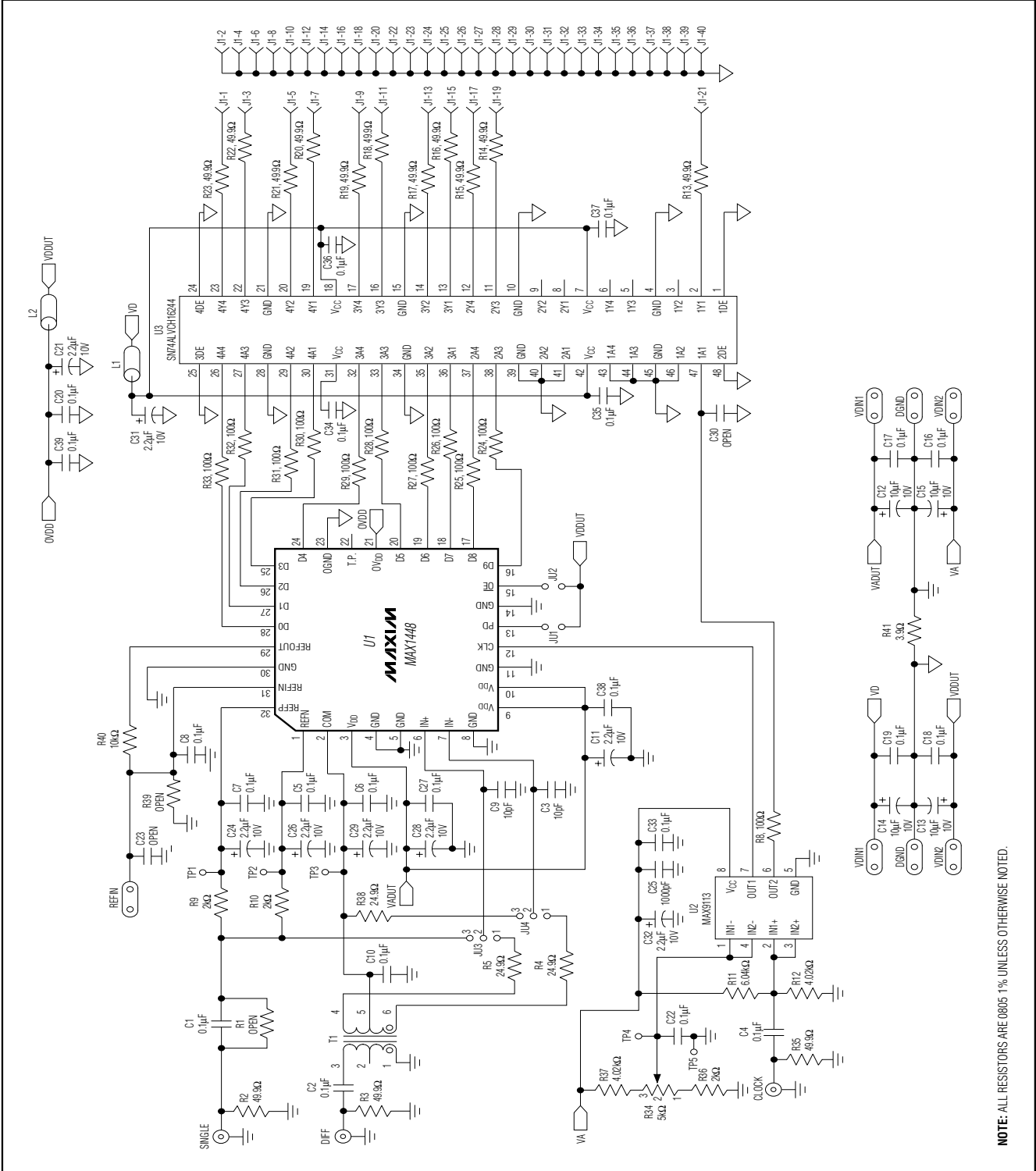

Figure 1. MAX1448 EV Kit Schematic



NOTE: ALL RESISTORS ARE 0805 1% UNLESS OTHERWISE NOTED.

# MAX1448 Evaluation Kit

## Output Buffer/Driver

The SN74ALVCH16244 buffer/driver buffers the MAX1448's digital output, which produces straight offset binary data. The buffer is able to drive capacitive loads, which may be present at the logic analyzer connection,

without compromising the digital output signal. The outputs of the buffer are connected to a 40-pin header (J1) located on the right side of the EV kit where the user can connect a logic analyzer or data-acquisition system.

Evaluates: MAX1444/MAX1446/MAX1448/MAX1449

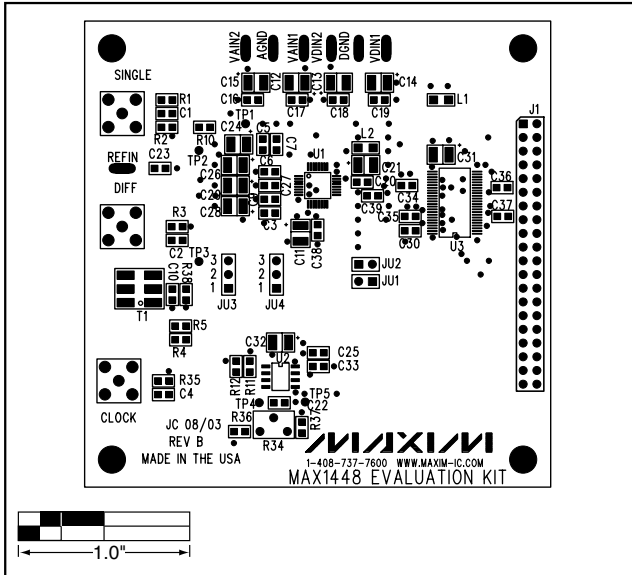

Figure 2. MAX1448EV Kit Component Placement Guide—Component Side

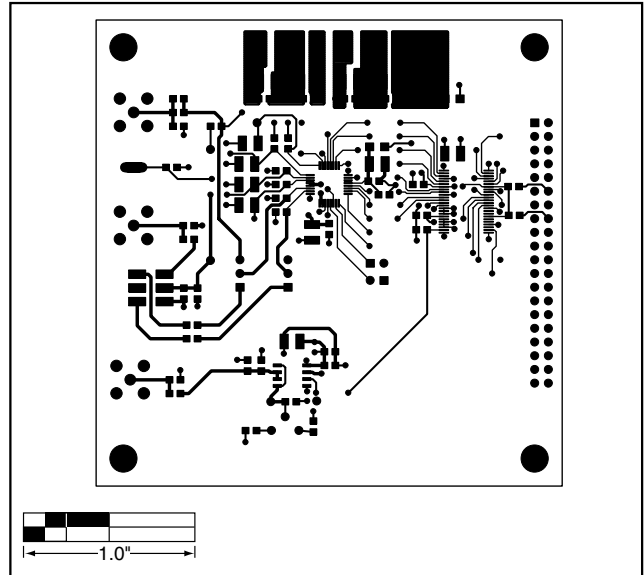

Figure 3. MAX1448EV Kit PC Board Layout—Component Side

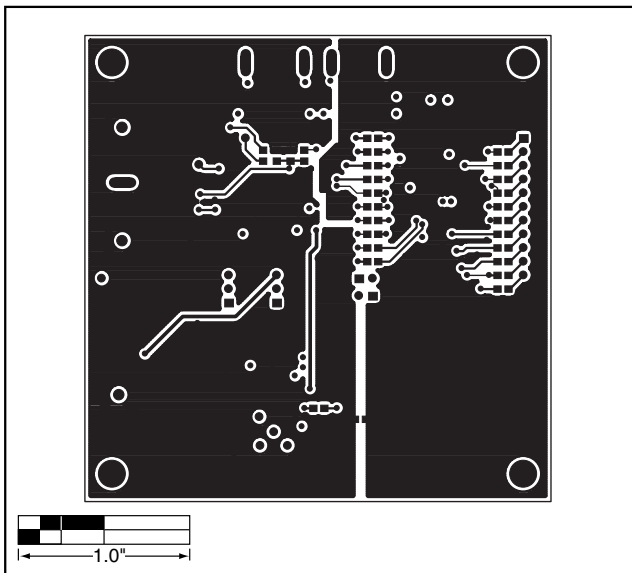

Figure 4. MAX1448EV Kit PC Board Layout—Solder Side

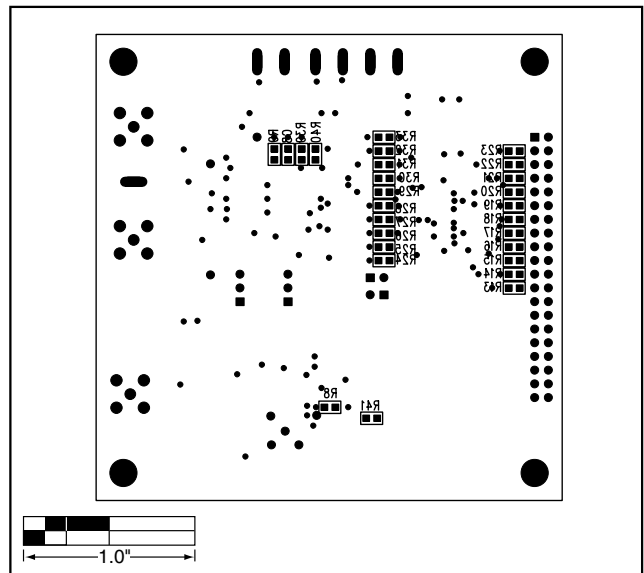

Figure 5. MAX1448EV Kit Component Placement Guide—Solder Side

# MAX1448 Evaluation Kit

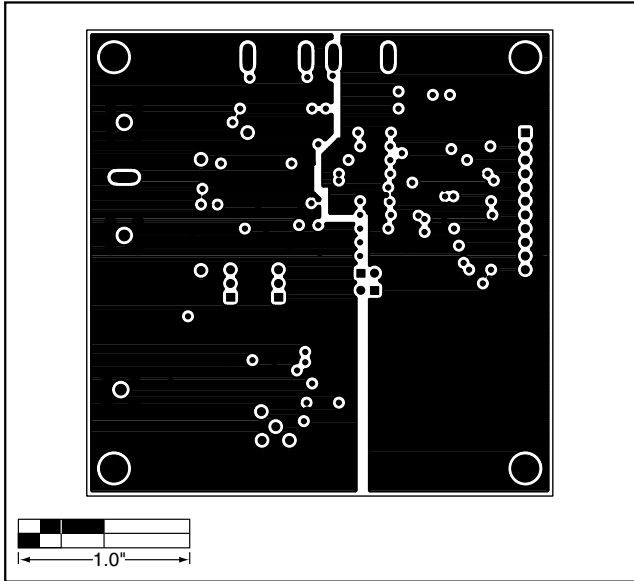

Figure 6. MAX1448EV Kit PC Layout—Ground Planes

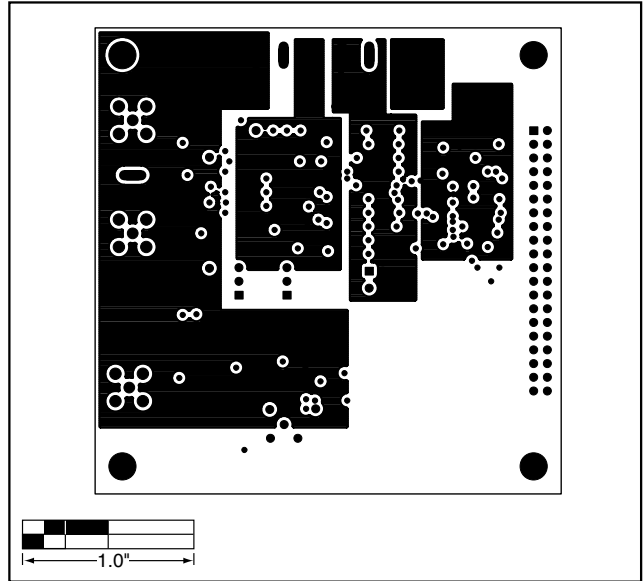

Figure 7. MAX1448EV Kit PC Layout—Power Planes

Maxim cannot assume responsibility for use of any circuitry other than circuitry entirely embodied in a Maxim product. No circuit patent licenses are implied. Maxim reserves the right to change the circuitry and specifications without notice at any time.

6 **Maxim Integrated Products, 120 San Gabriel Drive, Sunnyvale, CA 94086 408-737-7600**